

# *Progress* **REPORT**

Number four

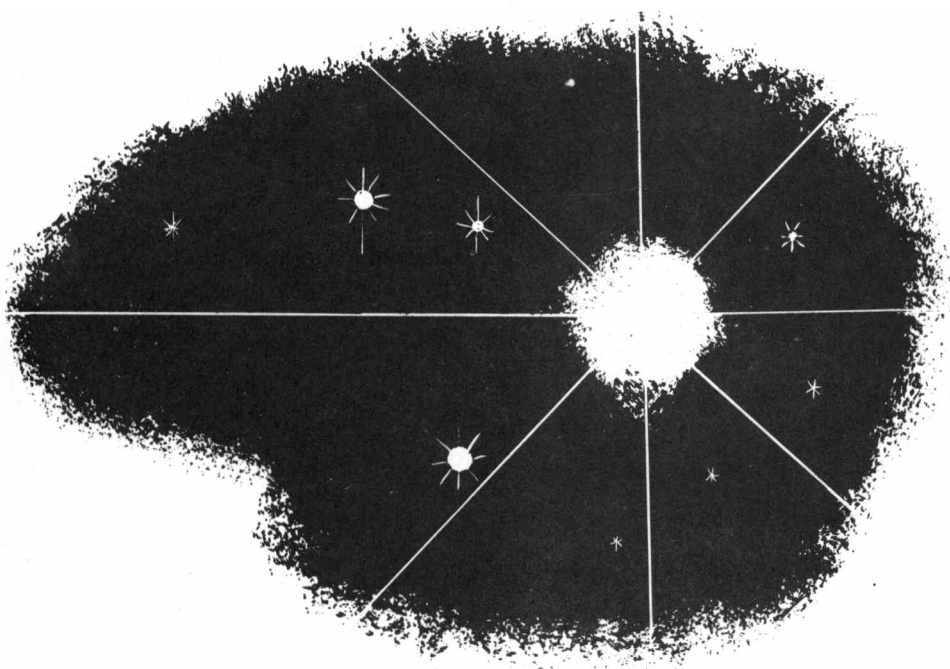

**11th WORLD SCIENCE FICTION CONVENTION**

# 11th WORLD SCIENCE FICTION CONVENTION

BOX 2019, PHILADELPHIA 3, PENNA.

## Officers:

Chairman - Milton A. Rothman, Ph. D.

Vice-Chairman - Tom Clareson

Secretary - Oswald Train

Treasurer - Robert A. Madle

## Executive Board:

Rules Committee - L. Sprague de Camp, chairman

Arrangements Committee - Irvin C. Heyne, chairman

Membership Committee - Jack Agnew, chairman  
Allison Williams, registrar

Program Committee - Lester Del Rey, chairman  
Milton Rothman, Phila. representative

Publicity Committee - Lyle Kessler, chairman  
Aides: Dave Eynon, Bob Tucker  
Joe Gibson, Harold Lynch  
Roy A. Squires, Bud Waldo  
A. J. Budrys

Art Committee - Russell Swanson, chairman  
Aides: Buddie McKnight, Sol Levin

Auction Committee - Sam Moscovitz, auctioneer

Sergeant-at-arms - William J. Jenkins

Progress Report - William J. Jenkins, editor

Program Booklet - David A. Kyle, editor

Auditor of financial statements - F. Leo Rodgers

Council for the committee - Benjamin R. Donolow

Official Convention Photographer - Joseph Zinni  
August 1, 1953 Issue

# 11th WORLD SCIENCE FICTION CONVENTION

BOX 2019, PHILADELPHIA 3, PENNA.

## Officers:

Chairman - Milton A. Rothman, Ph. D.

Vice-Chairman - Tom Clareson

Secretary - Oswald Train

Treasurer - Robert A. Madle

## Executive Board:

Rules Committee - L. Sprague de Camp, chairman

Arrangements Committee - Irvin C. Heyne, chairman

Membership Committee - Jack Agnew, chairman  
Allison Williams, registrar

Program Committee - Lester Del Rey, chairman  
Milton Rothman, Phila. representative

Publicity Committee - Lyle Kessler, chairman  
Aides: Dave Eynon, Bob Tucker  
Joe Gibson, Harold Lynch  
Roy A. Squires, Bud Waldo  
A. J. Budrys

Art Committee - Russell Swanson, chairman  
Aides: Buddie McKnight, Sol Levin

Auction Committee - Sam Moscovitz, auctioneer

Sergeant-at-arms - William J. Jenkins

Progress Report - William J. Jenkins, editor

Program Booklet - David A. Kyle, editor

Auditor of financial statements - F. Leo Rodgerz

Council for the committee - Benjamin R. Donolow

Official Convention Photographer - Joseph Zinni  
August 1, 1953 Issue

# Achievement Awards!

-----  
 BESTOR'S "DEMOLISHED MAN" LEADING AS BEST NOVEL IN EARLY VOTING!  
 FORREST J. ACKERMAN AND HARLAN ELLISON TIED FOR FAVORITE FAN!  
 -----

In Progress Report Number Three we announced that awards in nine categories of Science Fiction Achievement would be made at the Convention, and we printed a ballot listing the nine categories in that Report so that each and every member of the Convention could vote for his or her choices. While it is still too early to predict outcomes, and only a small number of members have already sent in their ballots, we're reporting the "early returns" as a matter of general interest.

There is still time to (a) do a little campaigning to line up a solid bloc of votes for your favorites, (b) get some members ---every membership is a potential vote for your favorites, and (c) get your own votes in before our August 25th postmark deadline. In the categories of outstanding FAN MAGAZINE, COVER PAINTING, INTERIOR ILLUSTRATION and SHORT STORY OR NOVELETTE the field is wide open, with no front-runners yet. So far, Bestor's Demolished Man is leading in the NOVEL class, with Bob Tucker's Long Loud Silence in second place. Most votes for favorite FAN are divided between old-timer Forrest J. Ackerman and new-timer Harlan Ellison. Galaxy is just edging Astounding as favorite PRO MAGAZINE. Willy Ley's For Your Information. James Gunn's Philosophy of Science

Fiction, and Robert Madle's Inside Science Fiction are leading in the FACT ARTICLE category, and illustrator Ed Emsch, authors Philip Jose Farmer and Robert Sheckley are all choices for outstanding NEW DISCOVERY. Of course, returns in the next couple of weeks could considerably alter the above picture; we're sitting in a neutral corner hollering only "May the best fans win!"

We have received numerous requests, complaints, protests and general hell-raising from fans who don't want to mutilate (!) their Number Three Report, asking us to change the rules so that they may vote without having to cut the ballot out of that Report. To this end, we are enclosing postal cards which may be used instead of the official ballot. Just fill out these cards and mail them to us. Print or write plainly. Remember to put YOUR NAME and YOUR CONVENTION MEMBERSHIP NUMBER on the card.

The nine categories are:

1. NOVEL
2. NOVELETTE OR SHORT STORY
3. FAN PERSONALITY
4. PROFESSIONAL MAGAZINE
5. COVER PAINTING
6. INTERIOR ILLUSTRATION (S)
7. FAN MAGAZINE
8. FACT ARTICLE (S)
9. NEW DISCOVERY (author or artist)

Please be specific as possible in naming your choices.

HAPPY VOTING!

CHAIRMAN'S MESSAGE

Time proceeds in its merry course, and the date of the big convention looms ahead of us. Memberships pour in at an increasing rate, the program keeps filling out, and the sense of excitement mounts as the great event draws near.

Much has happened since the last Progress Report, as a look at the convention program (printed on another page) will show. Fletcher Pratt is our latest and proudest addition to the program. This is a first for him and for us. It is his first convention, and having heard him speak elsewhere, we know that he will make an exciting climax to an afternoon's session.

In addition to the formal program, we have not forgotten what some people feel is the most important phase of a convention: having a good time. A convention is a place to convene, to talk to other people, to have fun. On Saturday night

there will be plenty of opportunity to relax up in the roof garden, where we will have our private bar.

Concerning the much-beat-about Masquerade Ball, the final decision is this: there will be a costume party. We have bowed to public opinion and have scheduled the party to be held after the banquet. The New York Science Fiction Circle is in charge of all details concerning the party and will work assiduously to ensure that it will be an enjoyable affair.

The Convention Committee has done its best to create a program that will satisfy most of the people most of the time. Beyond that the convention is in your hands. Your spirit, your participation, your enthusiasm are what will ensure the success of the convention. Anyone who fails to have a good time has only himself to blame.

\*\*\*\*\*  
\*\*\*\*\*

DEPARTMENT OF MISSING PERSONS

We are unable to send Progress Reports to the following people because of insufficient addresses. If you know where any of these people live, please send us a card, or inform the person involved.

- Donald Wolheim
- Ronald Cirkund
- Sten (?) Ten Eyck
- Tom Garrigan
- Lewis J. Grant
- Juanita R. Wellons
- Dewey Scarborough
- Irene Baron

- R. G. Meyering, Jr.
- John H. Hart
- Peter Graham
- Thelma D. Hamm
- Jim Goldfrank
- Barbara G. Bowden
- Woody Ayres
- Sterling Macaboy

Tom Reamy

**ATTENTION ALL MEMBERS!** Please be sure to inform us of change of address, since the Post Office does not forward second-class mail. Even though this is the last Progress Report, we still are going to mail a copy of the Program Booklet to all those who do not attend the convention.

\*\*\*\*\*

# ATTENTION !!

Last Call for ADS In The

CONVENTION PROGRAM BOOKLET

**Rates:**

For fan greetings and ads: Full Page \$15.00  
 Half Page 8.00  
 Quarter Page 5.00

Your name in print with a greeting for ONE QUARTER DOLLAR

For professional and commercial advertisements:

Full Page \$35.00  
 Half Page 20.00  
 Quarter Page 12.50

SEND YOUR ADS DIRECTLY TO THE EDITOR OF THE CONVENTION PROGRAM:

David A. Kyle  
 300 West 67th Street  
 New York 23, N. Y.

DEADLINE:  
 August 10, 1953

**FREE FREE FREE**

*Reedmor Magazine Co.*

**BOOKS AND BACK NUMBER MAGAZINES**

607 Market Street  
 Philadelphia 6, Pa.



FREE OFFERS FREE

Philadelphia's Oldest and Largest -- Specializing in SF  
 Rare SF Magazines and Books  
 Blackwood's from 1812 to 1910, Argosy, Astounding, etc.

**FREE OFFERS FREE**

TO ALL SF FANS WHO VISIT US DURING PHILCON 2  
 ONE FIRST EDITION SF MAGAZINE FREE

COME AND BRING YOUR FRIENDS!

# PROGRAM

for The 11th World Science Fiction Convention

At The BELLEVUE-STRATFORD HOTEL

\*\*\*\*\*

SATURDAY, September 5th

Morning: Registration

Afternoon: Main Ballroom

- 2 PM. Call to order by Irvin C. Heyne.  
Presentation of gavel to chairman.  
Welcome and keynote address.  
Report of Rules Committee and adoption of  
convention rules. L. Sprague de Camp.  
Announcements and introductions

Address by Willy Ley, Guest of Honor.

5 PM. Evening recess.

Evening: Burgundy Room

8 PM. Auction

9 PM. Meeting of NFFF.

9 PM. Informal gathering in roof garden. (Pay bar)

SUNDAY, September 6th

Morning: Main Ballroom

10 AM. Science Fiction Abroad.

Bert Campbell, Editor of Authentic Science Fiction  
(England)

Tetsu Yanu (Japan)

"The Future of Love -- a non-scientific fiction."  
by Irvin C. Heyne

Afternoon: Main Ballroom

1 PM. Introduction of Robert Bloch, M.C.

Humor by George O. Smith

Symposium: "Science Fiction as a Career."

L. Sprague de Camp (writing)

Lester Del Rey (editing and agenting)

Robert W. Lowndes (fans who have become pros)

Contest of plays and skits. Irvin Heyne, M.C.

THE PROGRAM (Continued)

SUNDAY, September 6th

Evening: Main Ballroom

- 7 PM. Banquet.
- Isaac Asimov, MC.
- Presentation of awards.
- Entertainment.

MONDAY, September 7th

Morning: Main Ballroom

- 10 AM. Debate: Is the present method of choosing convention sites the best one?
- Discussion of permanent convention organization.
- Led by David A. Kyle.
- Presentation of resolutions and general discussion.

Afternoon: Main Ballroom

- 1 PM. "Is Science Catching Up With Science Fiction?"
- "Computing Machines." Fletcher Pratt.

Evening: Main Ballroom

- 8 PM. Election of site of next convention.
- Continuation of auction.
- Drawings for door prizes, etc.
- Farewell....

\*\*\*\*\*  
\*\*\*\*\*

This is a somewhat tentative line-up for the program. The final program should be pretty much the same as the above except for any important additions which we may get in the meantime. We are, of course, still working to secure the best and most important names in the field to make this the most enjoyable stf convention program possible.

We hope that you will enjoy it.

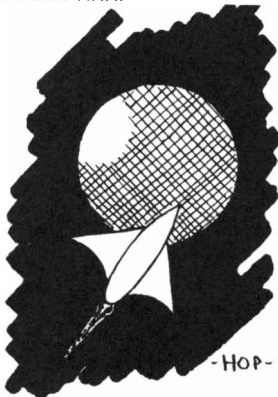

-Hop-



## COMMITTEE REPORTS

### PUBLICITY COMMITTEE

There has been a consistent change of Publicity Chairmen for the convention, starting with Tom Claerson--who left for a teaching position in Labrador Alan E. Nourse--who left on vacation in June, and ending with myself, Lyle Kessler. Nevertheless, the publicity has been exceptionally good. Both the professional editors and the fan magazine editors have kept a steady announcement of the convention in their mags. For this we cannot thank them enough.

But now on to the latest Publicity notices for the 11th World Convention.....

THERE WILL BE a Costume Party at the con! This will be sponsored by the New York Science Fiction Circle, and special "Certificates" will be presented to everyone coming in costume. Dave Kyle states that an attempt is being made to get a color photograph of the masquerade as a cover on a professional science fiction magazine.

As for outside publicity, Dave Eynon, well known writer for Weird Tales, is taking care of Newspaper coverage. Also, all the large national news and general magazines have been contacted. A few t.v. appearances and radio announcements are in the planning stage.

And finally after a long and certainly tiring year the publicity work is almost over. We would like to thank wholeheartedly the editors, fans, readers, and writers of science fiction who over the past year have helped to publicize the convention. To try to list all of these wonderful people would

be impossible; it would take up the whole Progress Report. But we want them to know that their help and advice has been greatly appreciated. We hope the next convention, where ever it may be, receives the same fine support that we have had.

### ARRANGEMENTS COMMITTEE

The Chairman of the Arrangements Committee expected to be overwhelmed by an avalanche of inquiries concerning transportation problems and car-pools for distant fans. But there have been very few requests. Perhaps the more remote fans have perfected teleportation. However, Marion Mallinger, 734 Mellon Street, Pittsburgh 6, Penna., is arranging a train pool at reduced rates for those fen in the Smoky City area. And in Chicago, Evan H. Appelman, 133 Laurel Avenue, Highland Park, Illinois, is the person to contact if you want transportation or passengers. And last, but not least, Barbara Bowden, RFD #1, King Street, Bay Shore, Long Island, New York, would like a ride over.

Early arriving fen will be registered on Friday evening in the Convention suite. Be sure to report there, if you arrive on Friday. For general benefit of members, we will maintain an information booth in the main lobby of the hotel between sessions. You will find it handy for leaving and receiving messages, contacting friends, etc.

For those who will want souvenirs of what should be a great occasion, we have secured the services of Joseph Zinni, one of Philadelphia's outstanding photographers. Joe will be taking pictures all during the convention and in many cases will be able to turn finished

ART COMMITTEE

work over before the convention is over. To make these pictures more interesting and valuable many of them will be shot against a special sciencefictional background which is being prepared by artist Russell Swanson. They should serve as a lasting momento of the 1953 convention.

Since time is getting short, if you want to form a car pool or want transportation, write directly to:

Irvin C. Heyne  
272 Trent Road  
Penn Wynne  
Philadelphia 31, Penna.

\*\*\*\*\*

ANOTHER REMINDER about hotel reservations: get your reservations in now because the best rooms are going fast. Remember The Bellevue-Stratford has a standard price for all rooms during this convention. Fill out the card which was enclosed with the third Progress Report, and mail it in NOW!

\*\*\*\*\*

The Art Committee wishes to thank all those who submitted art work to us for the Progress Reports. While most of it was very good, we are sorry that the restrictions of space allowed us to use only a few of the many fine pieces of work sent us. We hope it will not be long until the work of such men as Joe Love and Anthony de Luna is seen in more professional magazines than this. You have all made our job easier.

- - - - -  
- - - - -

TABLES FOR EXHIBITS AVAILABLE

Tables for the exhibition of professional or fan publications will be available at the convention. A very small fee will be charged for publishers and book-sellers. The use of tables for fans will be free. Write the Chairman of the Arrangements Committee for complete details.

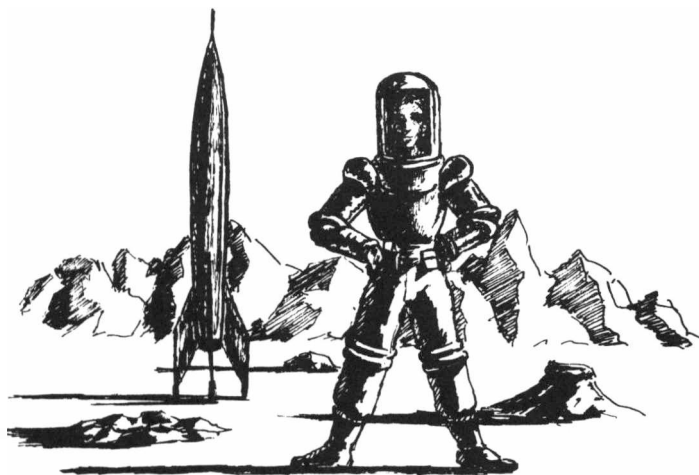

## Young Translator To Attend Convention Of Science Fiction

(Reprinted from the English Edition of The Mainichi, a Japanese Newspaper, for April 27, 1953)

KOBE, Apr. 26---In order to attend the 11th World Convention of Science Fiction to be held in Philadelphia on September 5-7, Tetsu Yano, 29, translator of science novels of Kobe will leave here on April 27.

He will board the M.S. Kamikawa Maru of the Kawasaki Kisen Kaisha at Yokohama on April 29.

Prior to attending the world convention, he will participate in the West Coast Convention of Science Fiction, which will be held in Los Angeles on May 30-31.

The young translator is going to America on the invitation of Forrest J. Ackerman, noted novelist, critic and agent for novels, whose nickname is "Mr. Science Fiction."

Yano became acquainted with Ackerman through his short articles, which appeared in American magazines "Startling" and "Imagination" under the title: "Letter From Japan."

Visiting the Mainichi Kobe branch office this morning, the youthful translator said that he wanted to tour 24 states in America by a Harley Davidson motorcycle, covering a distance of 28,000 kilometers starting from Los Angeles.

In his recent letter to Yano, Ackerman said in part:

"If ever you should be able to get to California, be assured that you would be most welcome at any Thursday night meeting of our Science Fiction Club.

"In fact, you would be Guest of Honor. My wife and I would be most pleased to have you as a guest in our home, sleeping and eating here without charge, while you were visiting Los Angeles.

"I would try to arrange for you to visit a motion picture studio, and do anything else within my power to make your stay pleasant.

"Of course you would be welcome to look at all my s.f. books and magazines, and I would arrange for you to meet such important s.f. personalities as Ray Bradbury and A.E. van Vogt...."

On April 10 Yano received a telegram from Ackerman reading: "Guarantee your maintenance while in U.S.A. also departure." Accordingly, he made up his mind to visit America and to attend the international convention.

---

So you see Forry is helping to make this a really international convention by his one-man "East Meets West" campaign.

Any fans who wish to aid 48J in his campaign may send contributions to:

Forrest J. Ackerman  
915 South Sherbourne Drive  
Los Angeles 35, Calif.

Remember, Forry is paying all expenses for Yano, during the Japanese fan's stay in this country.

DONATE TO THE "EAST-MEETS-WEST"  
FUND.....

ANNOUNCING...

A  
Portfolio  
of  
Illustrations  
by  
Virgil Finlay

Containing fourteen  $9\frac{1}{2}\times 12$   
illustrations, suitable for  
framing, printed on heavy  
velure paper. A limited  
edition. Sold by subscrip-  
tion only - - \$2.00.

Available September 5th,  
1953.

NOVA PRESS  
P. O. Box 2019  
Phila. 3, Pa.

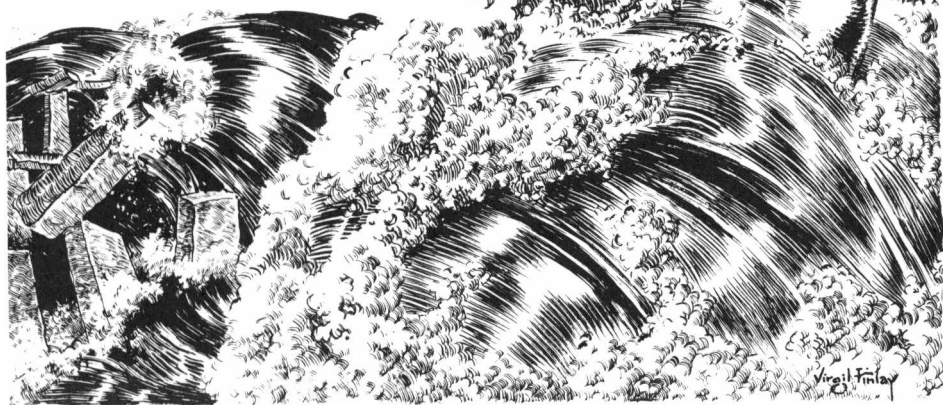

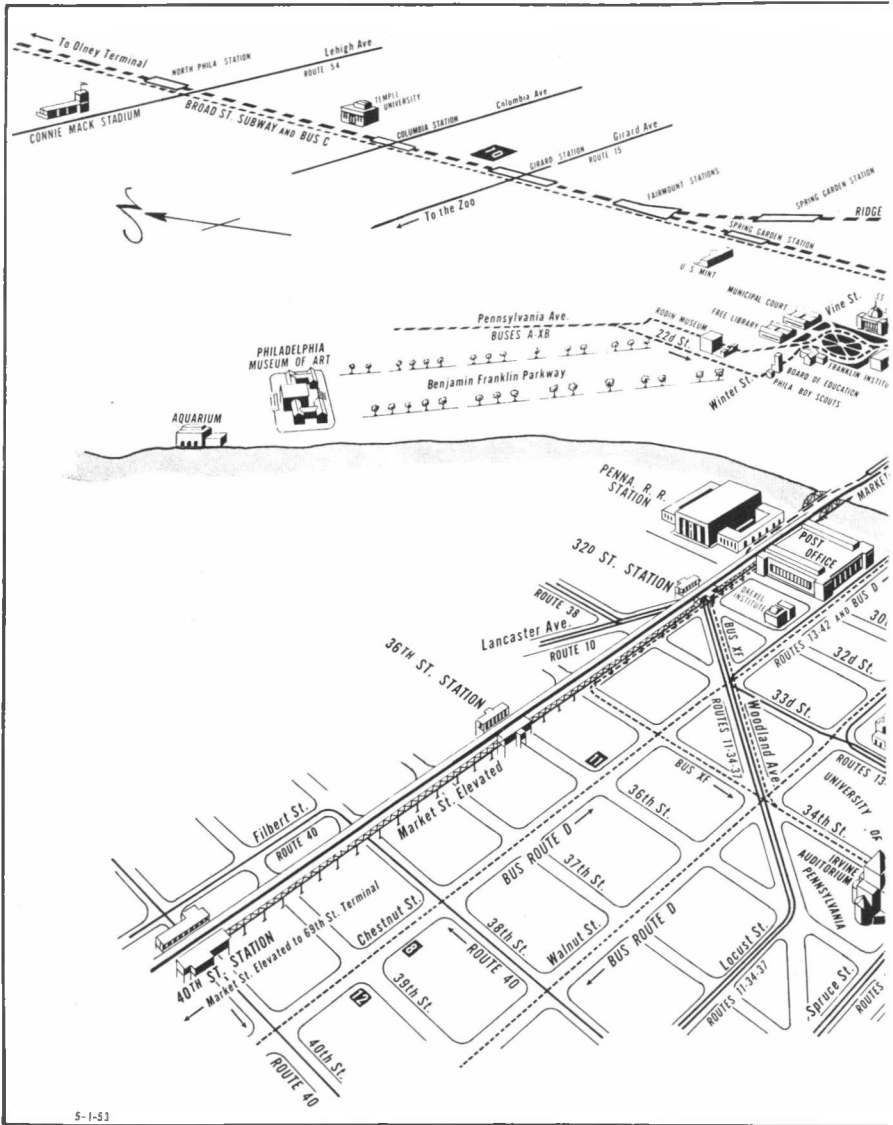

5-1-53

PHILADELPHIA • AMERI

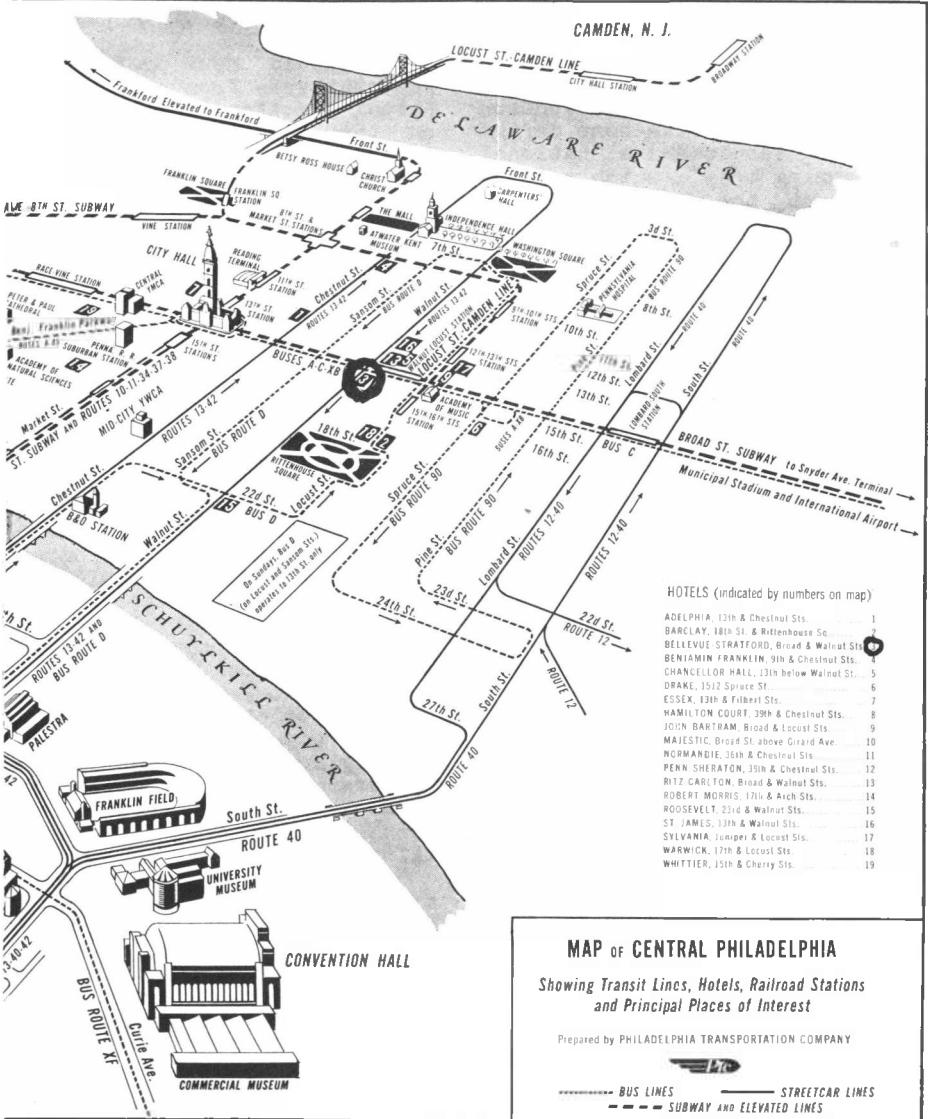

# CA'S CONVENTION CITY

THE QUESTION OF A NATIONAL ORGANIZATION FOR S F CONVENTIONS

-----  
 WILL FUTURE SCIENCE FICTION  
 CONVENTIONS BE HANDLED BY A  
 NATIONAL ORGANIZATION?  
 -----

This coming 11th Convention is expected to make some definite progress toward a "national sponsoring body", which a resolution at the 10th Convention in Chicago recommended for future science fiction conventions.

At the moment the question of what kind of "national sponsoring body" is wide open to suggestions. In order to permit everyone to offer ideas on this important subject, a sub-committee is compiling all suggestions for discussion at the Philadelphia convention. Much more interest in this vital problem is urged of all members --whether or not they are planning to be at Philadelphia.

Write down your ideas today and send them directly to David Kyle, 300 West 67th Street, New York 23, N.Y., who is chairman of the sub-committee on the National Sponsoring Body.

Dave, whose original resolution was passed at Chicago for the creation of such a body, says: "Every person in fandom, regardless of his age or experience, should make his ideas known to us. If ever there was a time when a fan was needed by fandom and responsible for its progress, that time is now. Please don't delay. Write that long letter or that succinct postal card to us today. You will be our guide to the decisions that must be made."

These questions in particular concern Dave's committee, and need your opinions and comments:

1. Should there be an Advisory Board to convention commit-

tees? How should the members be chosen?

2. Should there be fan representatives from each geographical section of the country on the convention committee? Should there also be representatives of other countries? How should they be chosen?

3. Should there be a permanent custodian-historian for all convention records?

4. Should there be a name given to the "national sponsoring body" which will be used year after year in order to give continuity and permanence to sf conventions? What name?

5. Should all former members of conventions be considered as "life members" of the "national sponsoring body" with current members of the current convention as the only "active members entitled to vote"? Should members who continue to demonstrate their interest year after year be given any recognition by using membership titles or grades of membership which carry no additional authority or voting power and remain completely honorary? Or should such members who earn such titles or grades be given increased responsibility? What responsibility?

6. Should fan clubs as units be asked to share in the burden of convention organizing? If so, should there be some sort of minimum requirement to determine which clubs are properly constituted? What requirements?

7. Should there be an official seal or insignia for conventions from year to year? Should there also be convention badges using such a seal?

Let Dave hear from you. What you have to say may greatly affect future sf conventions! you

you won't want to miss  
the new fourth issue of



# fantastic worlds

containing . . .

"last day," a story of the first moon rocket, the men  
who fly it, and the women they leave behind

by a. bertram chandler

"calling dr. caligari," a criticism of hollywood horror  
movies, with a list of the fifteen most truly hor-  
rible scenes--illustrated with stills from the  
original films

by robert bloch

"through crisis with the gonedaids," a modern allegory  
in a brilliant experimental style

by david r. bunch

"the horsemen," a story of children and the war of the  
future

by sam sackett

single copies now thirty cents

a year's subscription (four issues) still only one dollar

**fantastic worlds**

1449 brockton avenue, los angeles 25, california



CONVENTION COMMITTEE MEMBERS

Names omitted in PR Number 2	523. Tom Carrigan	575. Robert R Reed
105. Joe Fillinger	524. Beth Smith	576. Niel DeJack
106. Karl Olsen	525. Dale E. Ditsler	577. Marie DeJack
107. Edith Ogutsch	526. Penny Rich	578. Warren de Bra
190. Jerome Stanton	527. James B. Cullum	579. Michael Weiner
191. Frederik Pohl	528. Roger Hunter	580. E. Janda
194. Judith Merrill	529. Daniel Manelli	581. J. Schaumburg- er
195. Richard Wilson	530. Virginia Woodhead	582. J. Quagliano
Names omitted in PR Number 3	531. John Truax	583. Inga Pratt
442. Charles Brown	532. Judith Weinberg	584. Evelyn Smith
443. Robert S. Adeler	533. Douglas M. Smith	585. Jack Coggins
444. David Macdonald	534. George W. Early	586. E. J. Burden
445. William Gaines	535. David Mosher	587. Charles Dye
446. Al Feldstein	536. Benjamin Lease	588. Stan Skirvin
447. Al Williamson	537. Stephen Lease	589. Joan Skirvin
448. Arthur C. Clarke	538. Norman Stanley	590. Frank Robinson
449. John R. Closson	539. Selma Linde	591. Lewis J Grant
426. Ronald Cikumund	540. Andre E. Rupert	592. L. Rothstein
427. Hans Santesson	541. James T. Burnett	593. Peter K. Bros
428. Daniel Tanenbaum	542. Erle Korshak	594. Bea Hevesh
429. Bert Hirshhorn	543. Irene Korshak	595. Francis Conway
430. Henry W. Chabot	544. Stephen Korshak	596. Sam S. Leaf
431. Walter Kubilius	545. Peter Davis	597. Bob Kranbeck
432. Frank R. Paul	546. Pat Gallagher	598. Edward A. Muth
433. Pat Sabater	547. Lionel Issen	599. Margaret Corry
NEW MEMBERS	548. William Berg Jr.	600. V. Hildreth
501. Barney Berlin	549. Sten Ten Eyck	601. Agnes Agnew
502. Bill Walker	550. Richard Metzler	602. P. S. Miller
503. Warren H. Keefer	551. Craig Sutton	603. John Preble
504. Michael S. Hart	552. June Kaufman	604. H. Moscovitz
505. John Wasso	553. Pearl Silver	605. S. W. Spencer
506. Dorothy L. Wulff	554. Kathy Harte	606. Irv Greenberg
507. Royal M. Hockner	555. E. Robert Klorig	607. Paul J Cathey
508. Thomas Bradley	556. James H. Lyles	608. Jack Lewis
509. Donald Eddy	557. Rusty Silverman	609. Syd Coleman
510. Bob Farnham	558. Eugene Walsh	610. Larry Cornell
511. William Clemson	559. Jerry Dynda	611. John D Brewer
512. David L. Barnett	560. Faye Nickel	612. Phyllis Scott
513. Edwin C. Laubach	561. Richard Nickel	613. Robert Boldt
514. David D. McGirr	562. Oliver K. Smith	614. Jean Wright
515. F. C. Benton	563. Raymond Runnels	615. Janie Lamb
516. Lyell Crane	564. H. W. Louderback	616. Rita Moore
517. Mary Sommerville	565. Joseph A. Bell	617. David A Mason
518. William F. Drake	566. Donald B. Day	618. Fred Prophet
519. Tom Karras	567. Azriel Rosenfeld	619. W Paul Ganley
520. W. Link	568. Earl Patterson	620. Keith Brandon
521. H. E. Adams	569. Jon Stopa	621. Ray Bean
522. Donald Rathke	570. Bertha J. Rich	622. J A Schreiber
	571. George R. Heap	623. Mary L. Morse
	572. James M. Harper	Continued on
	573. Anna K. Stimson	Page 19.
	574. H. J. Campbell	

J O I N

NOW

11th WORLD SCIENCE FICTION CONVENTION

SEND ONE DOLLAR TO THE  
11th World Science Fiction Convention  
Box 2019  
Philadelphia 3, Pa.

NEED CASH TO GET TO THE  
CONVENTION?

Sell your surplus science fiction books and magazines.

I'm in the market for any back issue stf magazines or books in good to mint condition. Send list of what you have to dispose of and I'll quote prices.

Or perhaps you're flush, need some mags or books yourself. If so, send for free list of items I have for sale.

Gerry de la Ree,  
277 Howland Avenue,  
River Edge, N. J.



*Jenrette*

### THE PROGRESS REPORTER

Here is the fourth and final Progress Report, and ye olde editor of same believes it is a good time to give a recap of the history of the 11th World as it has happened so far. It could well be titled "The Trials and Tribulations of Putting on a Science Fiction Convention."

DAVE HAMMOND, the editor of PR #1 has told you how some of the members of the Philadelphia Science Fiction Society went to the Chicago Con with the intention of bringing the 11th to the East; and how we succeeded beyond our original plans.

After we returned to Philly the fun started. If there was one thing that was consistent about this so far, it has been all the changes that occurred in the past year.

To show what we mean DAVE HAMMOND, after completing the first PR enlisted in the Air Force. ALAN NOURSE took over for PR #2 and asked if I would assist him with it. Then TOM CLARESON, who was head of the Publicity Committee left for a teaching position in Labrador. Alan also took over there. After Alan put out the second issue of the PR he asked if I would be editor of the third and fourth. Nourse, who has more energy than any three men (he is a medical student at The University of Pennsylvania, a constant contributor to many of the sf magazines and who worked very hard on the Convention Committee) is now taking a very well earned vacation. He is succeeded as Publicity Chairman by LYLE KESSLER.

We on the Convention Committee were saddened by the death of JIM WILLIAMS, then Chairman of the convention on March 22. MILTON A. ROTHMAN, who had been Chairman of the Philcon in 1947

was elected as the present Chairman.

Now we have just heard that BOB MADLE is going to move to Charlotte, North Carolina shortly before the convention, but that he will be back here for the shindig. It has been a job just finding new faces to fill old places.

Enough of this griping, it has been work, but it is still fun.

Your editor would like to thank publicly some of the people who have helped to lighten the burdens. Especially DAVE KYLE and the other members of the New York Science Fiction Circle, such as JEAN CARROLL, who have on many occasions come to Philly to attend convention meetings. Their advice, suggestions and assistance has been invaluable. LESTER DEL REY, who has run a complete article on the convention in his magazine. BOB TUCKER, who had done the same in his fan-

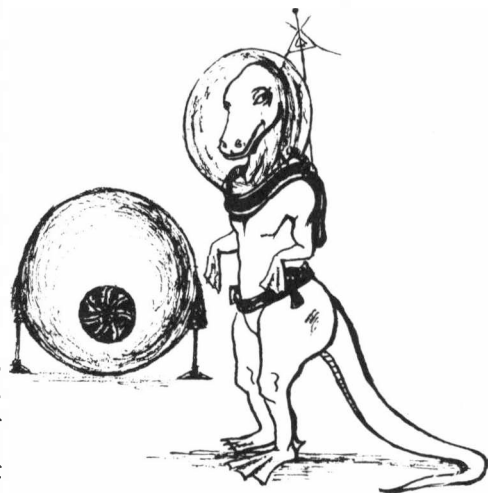

zine, and all those other professional and fan editors who have continuously plugged the coming con. To all much thanks.

MEMBERS ---CONTINUED.

Now before ye ed closes his Smith-Corona, gathers his "goon squad" about him and passes out the hand blasters (he doubles as your Sergeant-at-Arms at the con) here are some facts which should interest you.

THE MAP on pages 12 and 13 shows downtown Philadelphia. The Bellevue-Stratford is at Broad and Walnut Streets, in the heart of downtown Philly. It can easily be reached from the PRR and B&O Railroad stations.

Of interest also, is the news that the Fels Planetarium in the Franklin Institute is showing A Trip To Mars during September. If you have never been to a planetarium this is one show you should not miss during your stay in the City of Brotherly Love.

- 624. Ray Beam
- 625. Albert Lastovica
- 626. Roy A. Hempel
- 627. William P. Meyer
- 628. Deborah Heyne
- 629. Mary Nickels
- 630. Mary C. Kennedy
- 631. Joseph C. Belotte
- 632. Donald Skackelton
- 633. Emrys Evans
- 634. George Goodwin
- 635. James Goodwin
- 636. Sidney Anderson
- 637. Evelyn Anderson
- 638. Andrew Harris
- 639. Lester Mayer, Jr.

\*\*\*\*\*  
 \*\*\*\*\*  
 \*\*\*\*\*

CREDITS FOR PROGRESS REPORT #4

Interior Artwork: Joe Love, Hop  
 Hammond

Makeup: Jenkins

SEE YOU AT THE CONVENTION.....

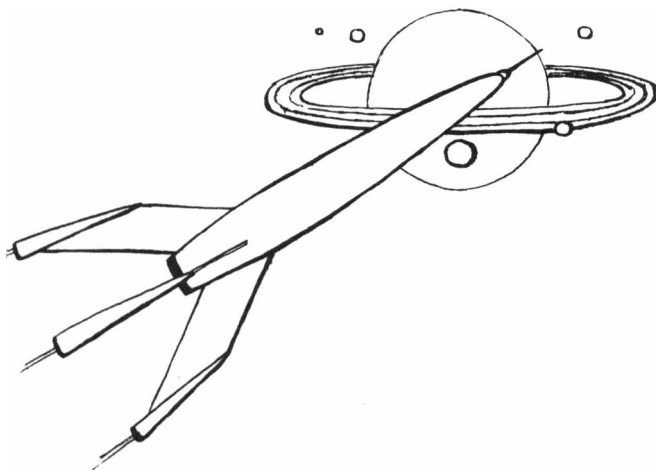

---

---

# PROGRESS REPORT

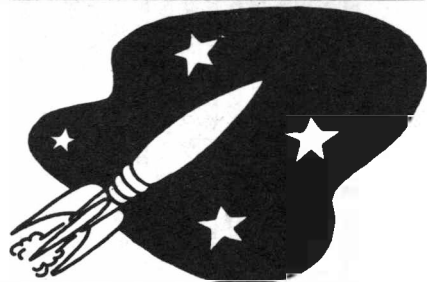

Published by the 11th World Science Fiction Convention.

---

---



Box 2019, Philadelphia 3, Penna.

Postmaster: Return postage guaranteed